



Grayhill, Inc.

62S11-M5-020CH

Onderdeel nummer:

62S11-M5-020CH

Vervaardiger / Brand:

Grayhill, Inc.

Produk Beskrywing

ROTARY ENCODER OPTICAL 32PPR

Inligtingsblaaie:

 62S11-M5-020CH.pdf

RoHS Status

 Loodvry / RoHS voldoen

Stuur Van

Hong Kong

Verskeping manier

DHL/Fedex/TNT/UPS/EMS

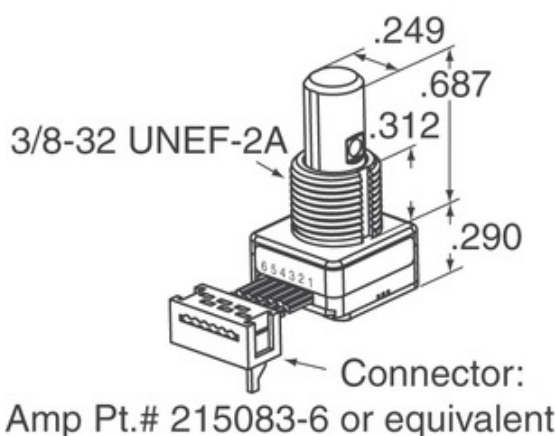
VERSOEK VIR KWOTASIE

Beeld kan voorstelling wees. sien spesifikasies vir produkinligting.







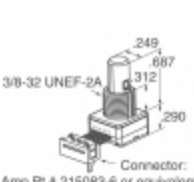

Spesifikasies van 62S11-M5-020CH

ONDERDEEL NOMMER	62S11-M5-020CH
VERVAARDIGER	Grayhill, Inc.
BESKRYWING	ROTARY ENCODER OPTICAL 32PPR
LEI VRYE STATUS / ROHS STATUS	Loodvry / RoHS voldoen
DATABLAD	 62S11-M5-020CH.pdf
SPANNING - VOORSIENING	5V
BEËINDIGINGSTYL	Cable with Connector
REEKS	62S
ROTASIE LEWE (CYCLES MIN)	1M
PULSE PER REWOLUSIE	32
UITGAWE TIPE	Quadrature (Incremental)
ANDER NAME	62S11M5020CH
GEAARDHEID	Vertical
MOUNTING TYPE	Panel Mount
VOGGEVOELIGHEIDSVLAK (MSL)	1 (Unlimited)
VERVAARDIGER STANDAARD LEVERTYD	8 Weeks
LEI VRYE STATUS / ROHS STATUS	Lead free / RoHS Compliant
ENCODER TYPE	Optical
DETENT	Yes
INGEBOUDE SKAKELAAR	Yes
AKTUATOR TYPE	1/4" Dia Flatted End

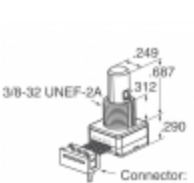
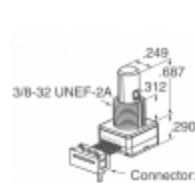
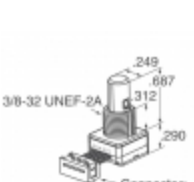
Verwante Tags

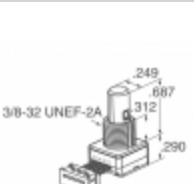
Grayhill, Inc. 62S11-M5-020CH	62S11-M5-020CH verspreider	62S11-M5-020CH Verskaffer
62S11-M5-020CH-prys	62S11-M5-020CH-foto's	62S11-M5-020CH-beeld
62S11-M5-020CH PDF-datablad	62S11-M5-020CH-datablad aflaai	62S11-M5-020CH-datablad
62S11-M5-020CH Voorraad	Koop 62S11-M5-020CH	Koop Grayhill, Inc. 62S11-M5-020CH
Grayhill, Inc. 62S11-M5-020CH	Grayhill, Inc. Verskaffer	Grayhill, Inc. verspreider
Grayhill, Inc. 62S11-M5-020CH	Grayhill Inc. 62S11-M5-020CH	

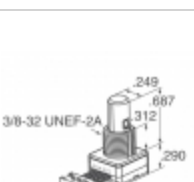
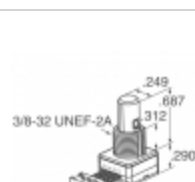
Verwante Produkte

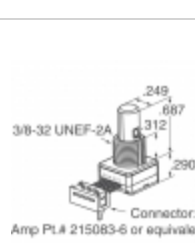
 <p>62S11-M5-040C vervaardigers: Grayhill, Inc. beskrywing: ROTARY ENCODER OPTICAL 32PPR Op voorraad: Out stock</p> <p>RFQ</p>	 <p>62S11-M5-020C vervaardigers: Grayhill, Inc. beskrywing: ROTARY ENCODER OPT 32PPR 2" CBL Op voorraad: Out stock</p> <p>RFQ</p>
 <p>62S11-M0-PV vervaardigers: Grayhill, Inc. beskrywing: ROTARY ENCODER OPTICAL 32PPR Op voorraad: Out stock</p> <p>RFQ</p>	 <p>62S11-M5-030CH vervaardigers: Grayhill, Inc. beskrywing: ROTARY ENCODER OPTICAL 32PPR Op voorraad: Out stock</p> <p>RFQ</p>
 <p>62S11-M0-200S vervaardigers: Grayhill, Inc. beskrywing: ROTARY ENCODER OPTICAL 32PPR Op voorraad: Out stock</p> <p>RFQ</p>	 <p>62S11-M5-050C vervaardigers: Grayhill, Inc. beskrywing: ROTARY ENCODER OPT 32PPR 5" CBL Op voorraad: 558 pcs</p> <p>RFQ</p>
 <p>62S11-M5-030C vervaardigers: Grayhill, Inc. beskrywing: ROTARY ENCODER OPTICAL 32PPR Op voorraad: Out stock</p> <p>RFQ</p>	 <p>62S11-M0-210SH vervaardigers: Grayhill, Inc. beskrywing: ROTARY ENCODER OPT 32PPR 20" CBL Op voorraad: Out stock</p> <p>RFQ</p>
 <p>62S11-M5-020S vervaardigers: Grayhill, Inc. beskrywing: ROTARY ENCODER OPTICAL 32PPR Op voorraad: Out stock</p> <p>RFQ</p>	 <p>62S11-M5-020SH vervaardigers: Grayhill, Inc. beskrywing: ROTARY ENCODER OPT 32PPR 2" CBL Op voorraad: Out stock</p> <p>RFQ</p>
 <p>62S11-M0-P vervaardigers: Grayhill, Inc. beskrywing: ROTARY ENCODER OPTICAL 32PPR Op voorraad: Out stock</p> <p>RFQ</p>	 <p>62S11-M0-PH vervaardigers: Grayhill, Inc. beskrywing: ROTARY ENCODER OPTICAL 32PPR Op voorraad: Out stock</p> <p>RFQ</p>