

ANT-418-WRT-xxx

Data Sheet

Product Description

The WRT Series antenna is ideally suited for applications such as wireless vending, security, traffic, or power equipment which require an unobtrusive, tamper-resistant antenna solution. The small 27 mm radome installs through a small hole on the product and is anchored by a threaded base. An adhesive foam compression ring is used to resist the elements. The antenna also features an integral counterpoise, which reduces the need for a proximity ground plane. The antenna is suited for mounting in applications where the counterpoise will not be shielded from the antenna (non-conductive or open metal enclosures); installation where the counterpoise is within a shielded enclosure will affect the antenna performance. The antenna's coax feed is available with SMA or RP-SMA terminations. Alternate coax lengths, connectors and custom colors are available for volume OEM customers.

Features

- Low cost
- Unobtrusive
- Tamper resistant
- Integral counterpoise
- Indoor / outdoor
- Adhesive or permanent mount

Electrical Specifications

Center Frequency:	418MHz
Recom. Freq. Range:	409–426MHz
VSWR:	≤ 1.9 typical at center
Peak Gain:	−1.3dBi
Impedance:	50-ohms
Oper. Temp. Range:	−30° to +90°C
Max. Recom. Torque:	4.0 kgf-cm

Electrical specifications and plots measured on 10.16 cm x 10.16 cm (4.00" x 4.00") reference ground plane

Ordering Information

ANT-418-WRT-RPS (with RP-SMA connector)
ANT-418-WRT-SMA (with SMA connector)

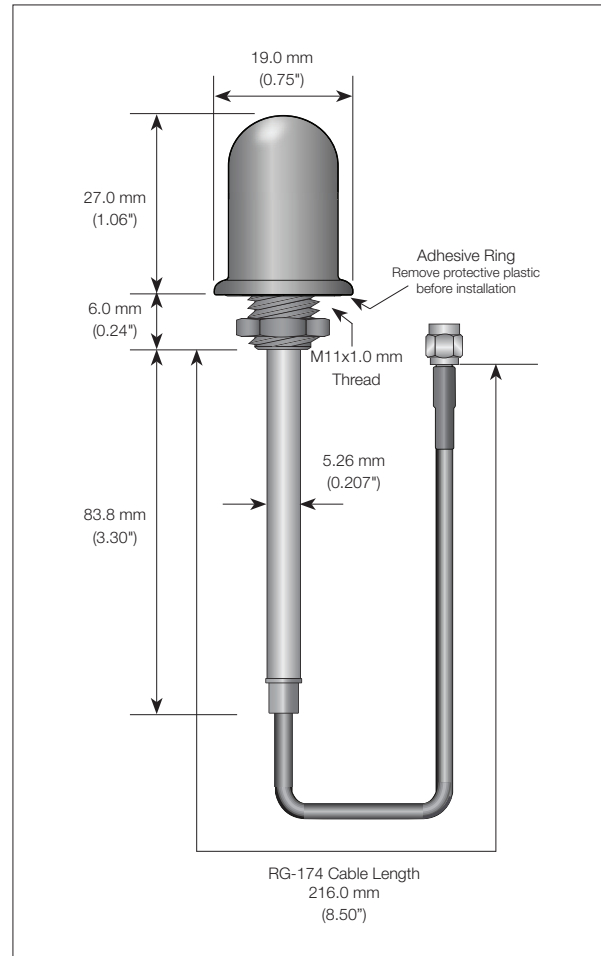

VSWR Graph

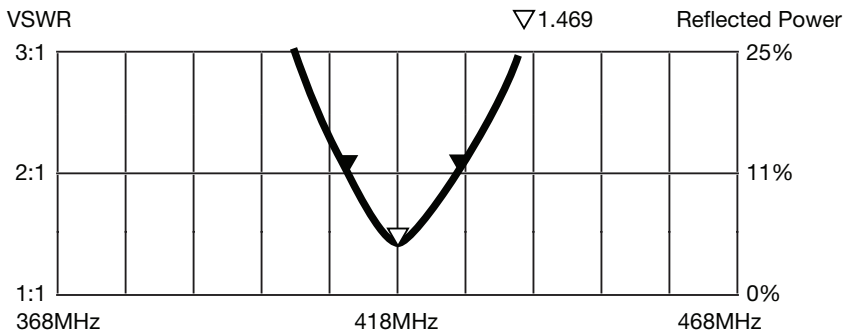

What is VSWR?

The Voltage Standing Wave Ratio (VSWR) is a measurement of how well an antenna is matched to a source impedance, typically 50-ohms. It is calculated by measuring the voltage wave that is headed toward the load versus the voltage wave that is reflected back from the load. A perfect match will have a VSWR of 1:1. The higher the first number, the worse the match, and the more inefficient the system. Since a perfect match cannot ever be obtained, some benchmark for performance needs to be set. In the case of antenna VSWR, this is usually 2:1. At this point, 88.9% of the energy sent to the antenna by the transmitter is radiated into free space and 11.1% is either reflected back into the source or lost as heat on the structure of the antenna. In the other direction, 88.9% of the energy recovered by the antenna is transferred into the receiver. As a side note, since the “:1” is always implied, many data sheets will remove it and just display the first number.

How to Read a VSWR Graph

VSWR is usually displayed graphically versus frequency. The lowest point on the graph is the antenna’s operational center frequency. In most cases, this will be different than the designed center frequency due to fabrication tolerances. The VSWR at that point denotes how close to 50-ohms the antenna gets. Linx specifies the recommended bandwidth as the range where the typical antenna VSWR is less than 2:1.